



THE
SPRAY NOZZLE
PEOPLE

ORBITOR 4

Rotary Jet



TANK WASH

DESIGN FEATURES

- ✓ Entirely fluid driven - no external power source is required
- ✓ Self lubricating
- ✓ Easy to maintain. Can be stripped and reassembled in 15 minutes
- ✓ ATEX certified zones 0 and T6
- ✓ Self cleaning and hygienic design suitable for food and pharmaceutical applications

SPRAY CHARACTERISTICS

- ✓ Flow rates: 80 - 458 L/min
- ✓ Working Pressure: 3 - 10 bar
- ✓ Jet length: Up to 13 metres
- ✓ Wash pattern: 360°
- ✓ Cycle times: 5.5- 15.5 minutes
- ✓ Materials:
 - Housing: 316L
 - Nozzle Head: 316L
 - Gears: PEEK + 316 SS
 - Bushings: Carbon Filled PTFE
- ✓ Weight: 8Kg



The Orbitor 4 is a fully self-cleaning machine and is made from food/ pharmaceutical grade hygienic materials.

It delivers powerful cleaning jets up to 13 metres in length. Its four nozzle configuration means that cycle times are reduced when compared to the 2 nozzle machine.

The Orbitor 4 is one of the only tank cleaners that is ATEX certified for use in all zones and temperatures.

CALL NOW : +44 (0) 1273 400092

www.spray-nozzle.co.uk

The Go-to People for spray nozzle solutions

How it works

The Orbitor 2 is a fluid driven rotary jet cleaner. The cleaning fluid is pumped through the Orbitor and this first passes through a turbine which causes the two nozzle arms to spin. The fluid then passes through the nozzles forming a powerful cleaning jet. As the arms rotate the main body also rotates in a set pattern. This is geared so that over a specific period of time (the clean cycle) the cleaning jets are brought to bear on each part of the tank ensuring a thorough, methodical clean.

For each configuration of Orbitor there will a maximum jet length for any given fluid pressure. The max jet length is the overall reach of the resulting spray. The effective cleaning jet length is smaller than this and represents the distance from the machine where a reasonable cleaning action will be achieved. Clearly a more robust clean will be given the further within the effective jet length the target sits.

Made in the UK



The Orbitor is manufactured in the UK exclusively for The Spray Nozzle People by Dasic Marine.

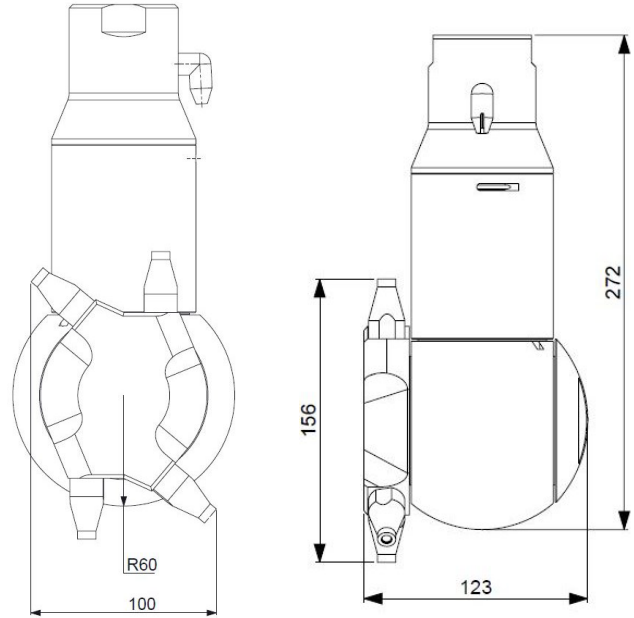

Orbitor 4

Flow rates, Jet Lengths and Cycle Times

Standard Materials: Housing: 316L, Nozzle Head: 316L, Gears: PEEK + 316 SS, Bushings: Carbon Filled PTFE

Model Type

Bar	4x4.2mm			4x5mm			4x6mm			4x7mm			4x8mm		
	Flow rate l/min	Jet Length (m)	Cycle Time (min)	Flow rate l/min	Jet Length (m)	Cycle Time (min)	Flow rate l/min	Jet Length (m)	Cycle Time (min)	Flow rate l/min	Jet Length (m)	Cycle Time (min)	Flow rate l/min	Jet Length (m)	Cycle Time (min)
3	80	2.9	11	112	4	13	138	5.3	15.5	217	6.5	20.1	250	7.2	15.5
4	100	3	9.3	137	4.2	10.8	170	5.7	12.9	252	7.1	15.2	293	8	12.9
5	115	3.5	7.9	155	4.7	9.4	200	6.2	11	283	7.7	14.9	333	9	11
6	127	4	6.9	173	5.2	8	220	7	9.5	310	8.5	13	367	9.9	9.5
7	138	5	6.3	185	6.3	7.3	240	8	8.4	333	9.4	11.7	395	10.6	8.5
8	147	6.2	5.8	195	7.5	6.8	257	9.4	7.6	350	10.3	10.4	418	11.2	7.8
9	153	7.1	5.6	202	8.5	6.5	270	10.3	7	367	11.2	9.3	438	12.2	7
10	157	7.8	5.5	207	9	6.4	282	11.2	6.9	380	12	8.9	458	13	6.9